

8 7 6 5 4 3 2 1

D

D

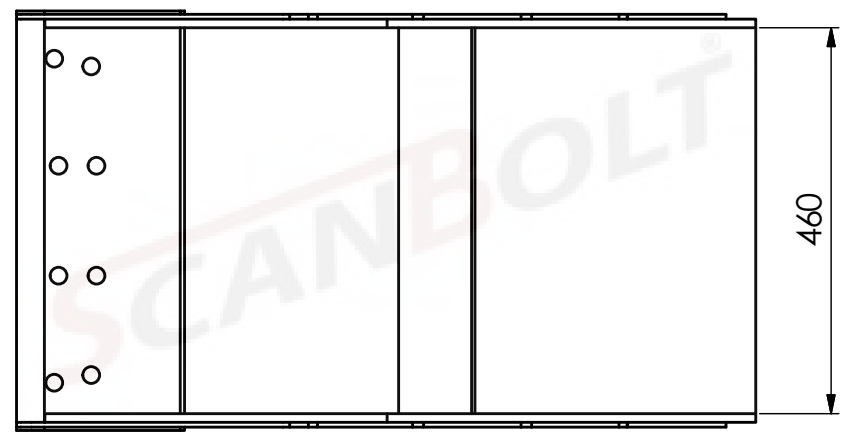
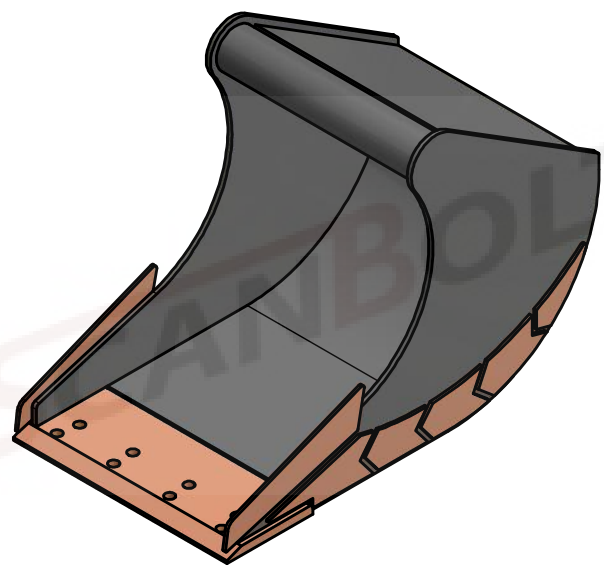

C

C

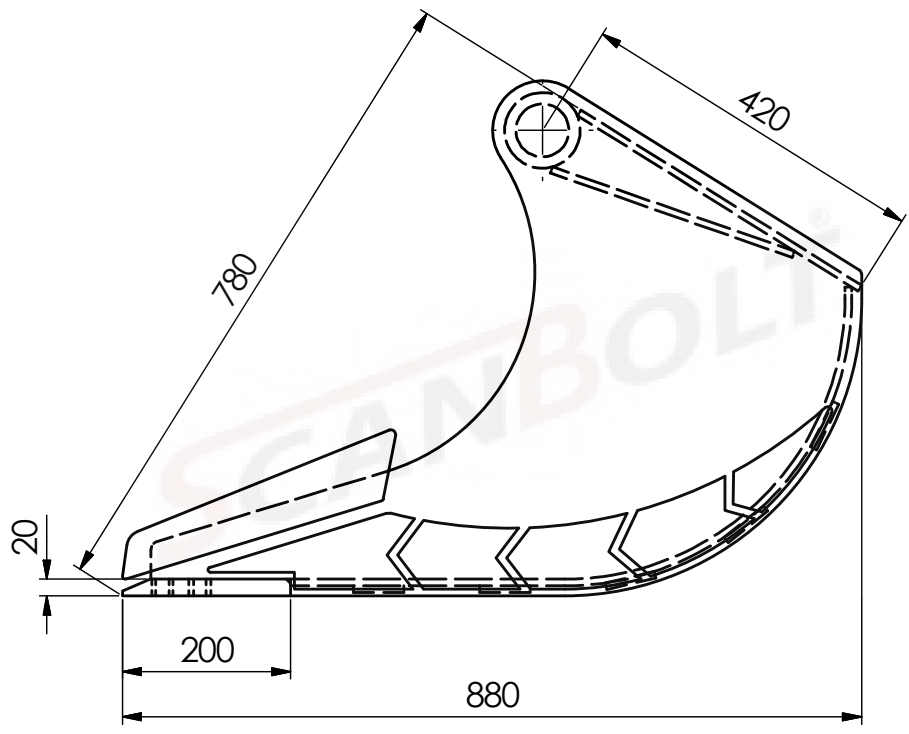
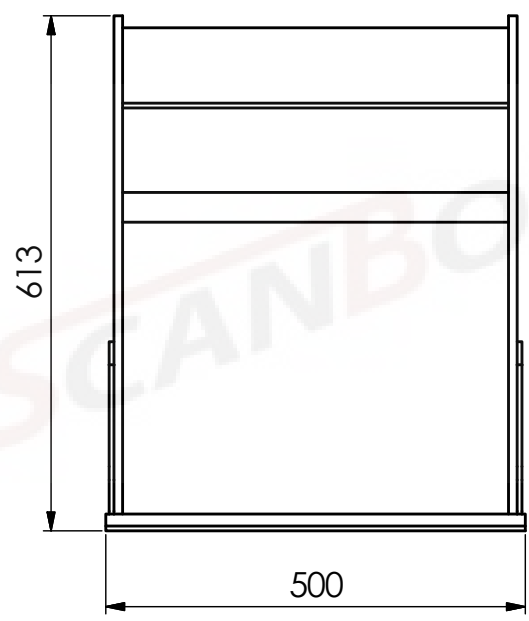





B

B

A

A

MATERIAL SPECIFICATION	
	ST52.3
	EN8D
	HB 400
	HB 450
	CASTALLOY STEEL

SCANBOLT®	
DESCRIPTION	50CM DIGGING BUCKET
MACHINE CLASS	5.0-7.4 TON
WEIGHT	128.7 Kg
HEAPED CAPACITY	153.7 LITERS

8 7 6 5 4 3 2 1